

**LACH
DIAMOND INC.**

presents for HSC/HPC Aluminum Machining

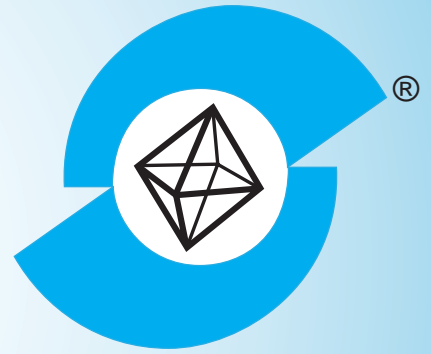

» Cool Injection-Plus «

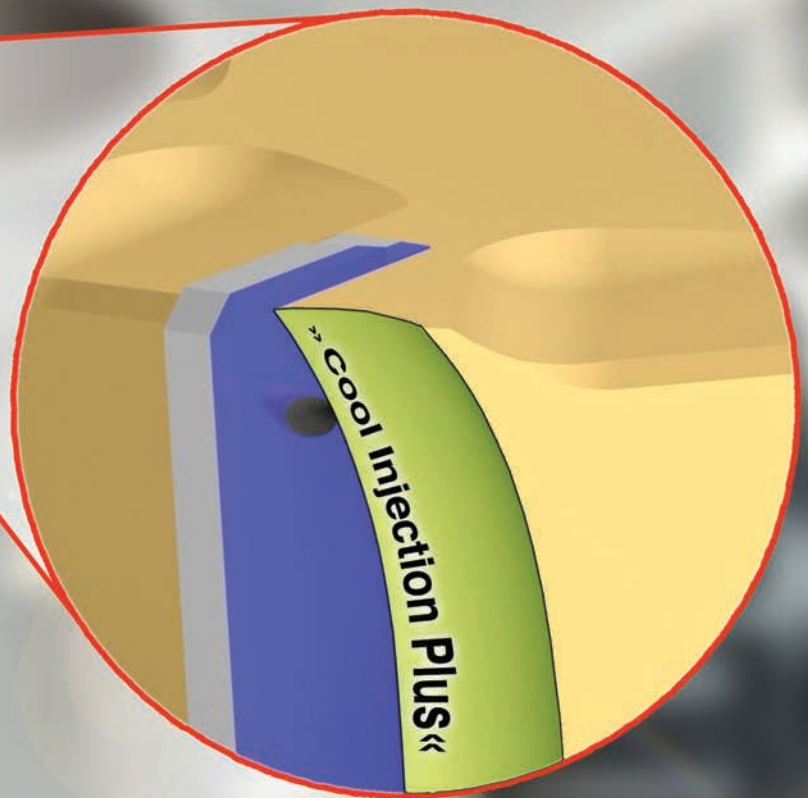

a perfect Innovation...

»Cool Injection« direct cooling



High Speed Cutting (HSC)
by maximum number of teeth

Perfect chip removal

Maximum feeds and depths of cut

High performance (HPC)
for pre- and finish-machining

Longer tool life
and better economy

with Chipbreaker »Plus«

Function of »Cool Injection-Plus«

»Cool Injection-Plus« channels the coolant - emulsion, oil, MMS, cryogenic - targeted through the open cutting edge of the PCD insert directly below the produced chip.

The combination of the »Cool Injection« cooling system and the »Plus« chipbreaker developed by the **AUDI AG** guarantees a safe, controlled and efficient machining of aluminum, especially in the automotive and component supplier industries, e.g. all around the engine block.

Maximum service life, extreme high cutting data and infeeds are obtained, as well as perfect surface finish and component accuracy, including high performance (HPC) and up to 50 % and more reduction of cycle time.

PCD cutters with »Cool Injection-Plus« are delivered completely assembled and balanced with the adapter of your choice and can be mounted immediately on the machine without adjustment expenditure.

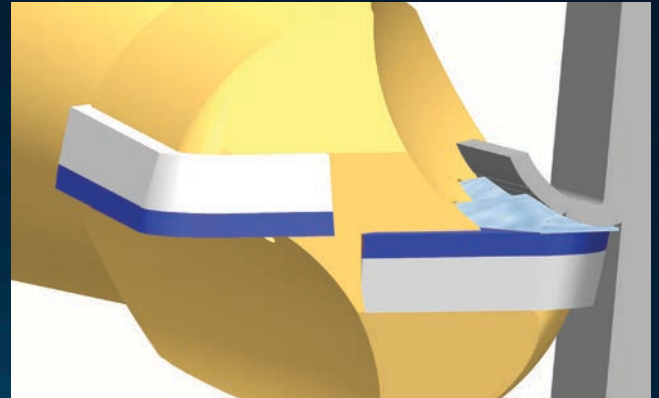

»Cool Injection«

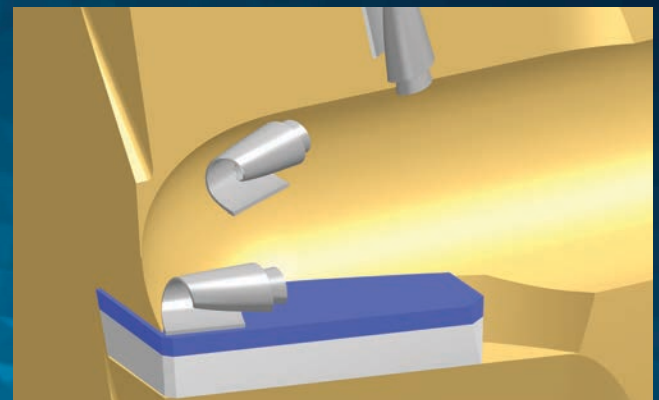

Chipbreaker »Plus«

»Cool Injection-Plus«

The ideal combination for innovative machining of aluminum

LACH

dreborid[®]

»Cool Injection« with Chipbreaker »Plus«

Type MB-H3

PCD Monoblock face and square shoulder milling cutter

from Ø 30 to Ø 63 mm

For innovative HSC/HPC aluminum machining

Particularly efficient:

- ◆ Feed: up to 40.000 mm/min.
- ◆ Cutting depth: up to 8 mm at maximum cutting speed
- ◆ Reduction of cycle time: 50 % and more possible

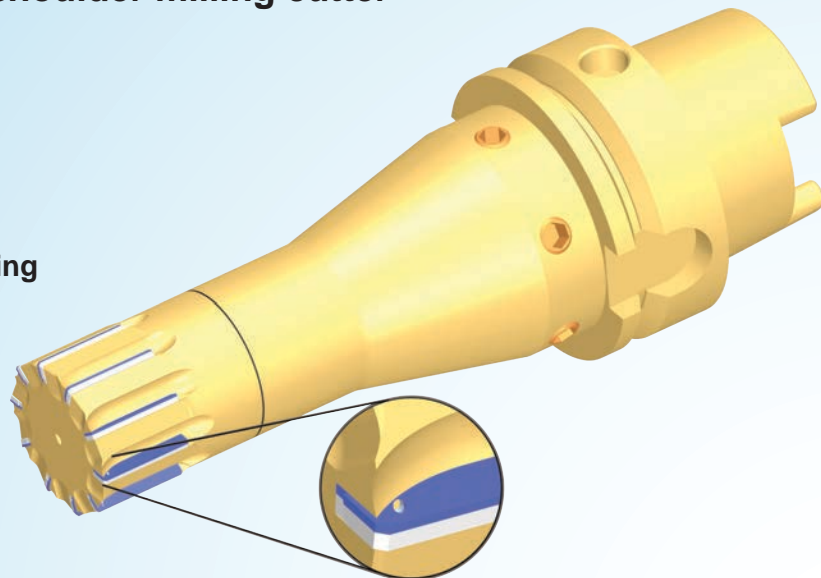

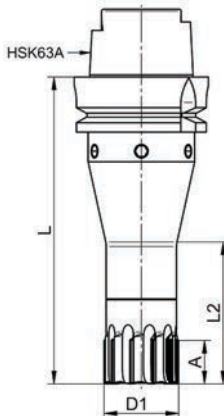
	Order Code	Dimensions					Adapter	Art. No.
		D1	A*	L	L2	Z*		
	MB-H3-30-15-100-Z8 HSK63A	30	15	100	35	8	HSK63A	42502050
	MB-H3-35-15-120-Z10 HSK63A	35	15	120	35	10	HSK63A	42502051
	MB-H3-40-15-150-Z10 HSK63A	40	15	150	35	10	HSK63A	42502052
	MB-H3-50-15-150-Z12 HSK63A	50	15	150	35	12	HSK63A	42502053
	MB-H3-63-15-150-Z16 HSK63A	63	15	150	35	16	HSK63A	42502054

*Depending on the requested performance (HPC) the diamond length A and number of teeth Z will be customized.

Alternative Adapters HSK80A / HSK100A and SK40 / SK50

Other dimensions according to your specifications.

LACH

dreborid®

»Cool Injection« with Chipbreaker »Plus« Type MB-E3

PCD Monoblock screw-in milling cutter
from Ø 16 to Ø 32 mm

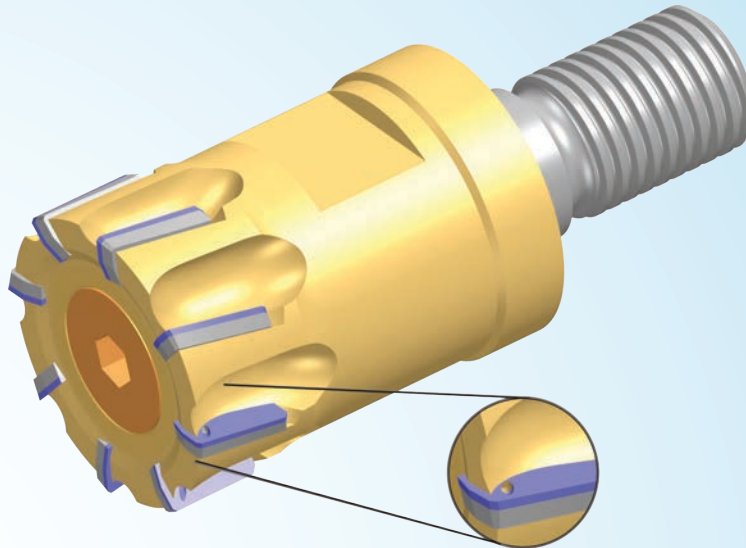

For innovative HSC/HPC
aluminum machining

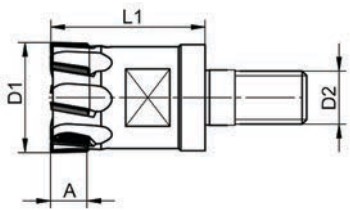
	Order Code	Dimensions					Art. No.
		D1	D2	L1	A	Z	
	MB-E3-16-8-Z5-M8	16	M8	25	8	5	42502040
	MB-E3-20-8-Z6-M10	20	M10	30	8	6	42502041
	MB-E3-25-8-Z8-M12	25	M12	35	8	8	42502042
	MB-E3-32-8-Z10-M16	32	M16	40	8	10	42502043

Adapter for screw-in milling cutter: see catalogue "Milling" page 16

Examples

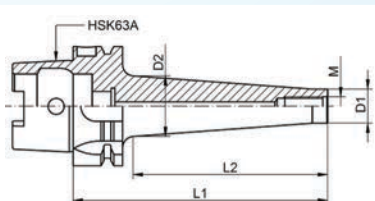

Adapter HSK63A

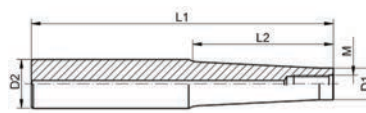

Cylindrical adapter with internal cooling

Note: For the machining of CFRP, GRP and adapters: see catalogue "Milling" page 15/16.

Other dimensions according to your specifications.

LACH

dreborid®

»Cool Injection« with Chipbreaker »Plus« Type MB-X3

HSC/HPC PCD Monoblock face and square shoulder milling cutter
from Ø 40 to Ø 200 mm

For innovative HSC/HPC
aluminum machining
Particularly efficient:

- ◆ Feed: up to 40.000 mm/min.
- ◆ Cutting depth: up to 8 mm at maximum cutting speed
- ◆ Reduction of cycle time: 50 % and more possible

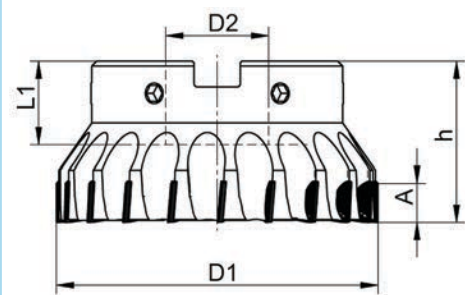
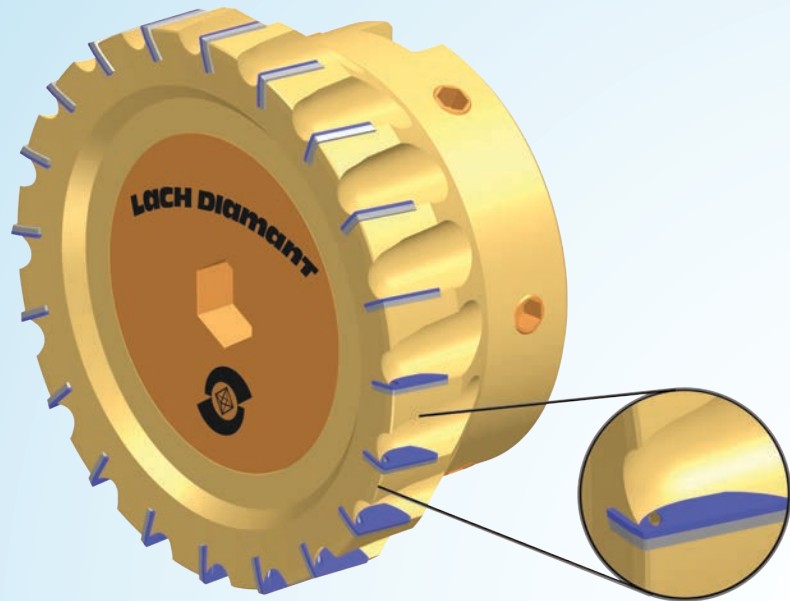

	Order Code	Dimensions acc. to ISO 6462						Art. No.
		D1	h	A*	D2	L1	Z*	
	MB-X3-040-08-Z8/F	40	40	8	16	21	8	42507101
	MB-X3-040-08-Z8/P							42507102
	MB-X3-040-08-Z8/R							42507103
	MB-X3-050-08-Z10/F	50	40	8	16	21	10	42507201
	MB-X3-050-08-Z10/P							42507202
	MB-X3-050-08-Z10/R							42507203
	MB-X3-063-08-Z12/F	63	45	8	22	21	12	42507301
	MB-X3-063-08-Z12/P							42507302
	MB-X3-063-08-Z12/R							42507303
	MB-X3-080-10-Z16/F	80	50	10	27	23	16	42507401
	MB-X3-080-10-Z16/P							42507402
	MB-X3-080-10-Z16/R							42507403
	MB-X3-100-10-Z20/F	100	50	10	32	26	20	42507501
	MB-X3-100-10-Z20/P							42507502
	MB-X3-100-10-Z20/R							42507503
	MB-X3-125-10-Z26/F	125	63	10	40	29	26	42507601
	MB-X3-125-10-Z26/P							42507602
	MB-X3-125-10-Z26/R							42507603
	MB-X3-160-10-Z34/F	160	63	10	40	29	34	42507701
	MB-X3-160-10-Z34/P							42507702
	MB-X3-160-10-Z34/R							42507703
	MB-X3-200-13-Z42/P	200	63	13	40	26	42	42507802

For surface finish:

F = $R_z < 5 \mu$

P = $R_z > 5 \mu$

R = $R_z < 20 \mu$

*Depending on the requested performance (HPC) the diamond length A and the number of teeth Z will be customized.

LACH

dreborid®

Chipbreaker »Plus« Type CFM-2

PCD face and square shoulder milling cutter with cartridges
from Ø 200 to Ø 400 mm

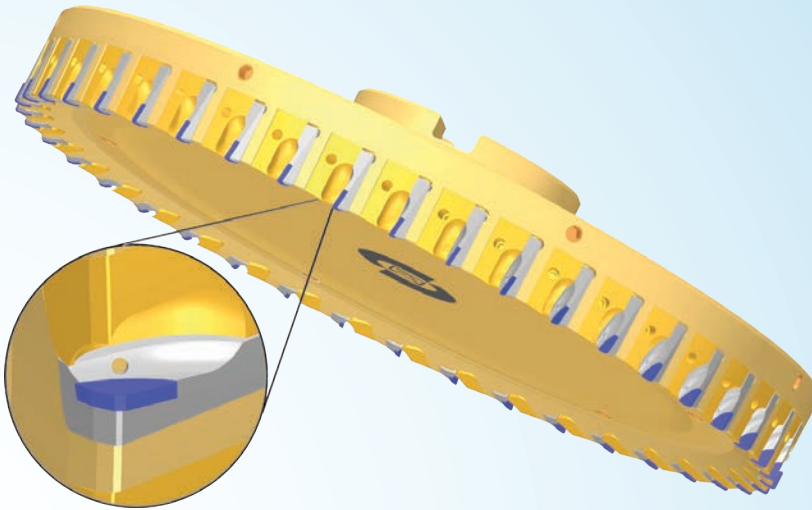

For HSC/HPC machining
with cartridges size 2
and chipbreaker »Plus«

- ◆ for infeeds up to 3 mm cutting depth.
- ◆ Feeds up to 40.000 mm/min.

Roughing cutters are supplied without
chipbreaker for cutting depth 8 mm
with cartridges size 1.

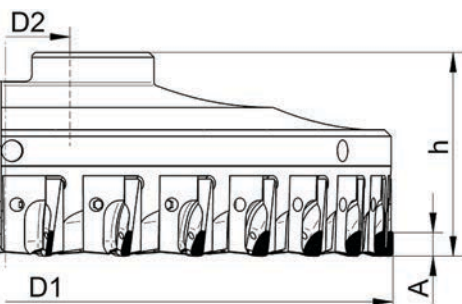
	Order Code	Dimensions					Art. No.
		D1	h	A	D2	Z	
	CFM-2-200-6-Z24	200	63	6	40	24	42404901
	CFM-2-220-6-Z28	220	63	6	40	28	42404903
	CFM-2-240-6-Z30	240	63	6	40	30	42404905
	CFM-2-260-6-Z32	260	63	6	40	32	42404907
	CFM-2-280-6-Z36	280	63	6	40	36	42404909
	CFM-2-300-6-Z40	300	63	6	40	40	42404911
	CFM-2-315-6-Z42	315	63	6	40	42	42404913
	CFM-2-350-6-Z46	350	63	6	40	46	42404915
	CFM-2-375-6-Z48	375	63	6	40	48	42404917
	CFM-2-400-6-Z52	400	63	6	40	52	42404919

PCD cartridges for face and square shoulder milling cutters with chipbreaker »plus«

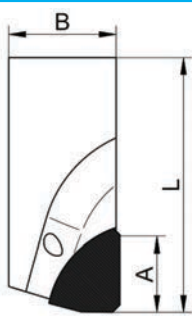
Size 2	Order Code	Dimensions			Art. No.
		B	L	A	
	D-CR 10x24-A6/P	10	24	6	42404731
	D-CR 10x24-A6/F	10	24	6	42404733
	D-CR 10x24-A6/FF	10	24	6	42404735

P= Standard cartridge

F= Finish cartridge

FF= Super finish cartridge
max. 2-4 cartridges in the face milling cutter

»Cool Injection-Plus«

LACH DIAMANT, the pioneer among the manufacturers of PCD tools since 1973 again presented a technical innovation at the IMTS in Chicago 2014.

»Cool Injection« with chipbreaker »Plus« for innovative aluminum machining

- ◆ High Speed Cutting (HSC)
- ◆ High Performance (HPC),
because the tool is designed with a maximum number
of cutting edges as multiple end mill
- ◆ maximum feed rates up to 40.000 mm/min.
- ◆ maximum depth of cut possible
- ◆ cycle time reduction of 50 % and more possible
- ◆ targeted chip breaking prevents chip accumulation
in delicate components
- ◆ maximum tool life,
because the chips do not have to be „cut“ several times

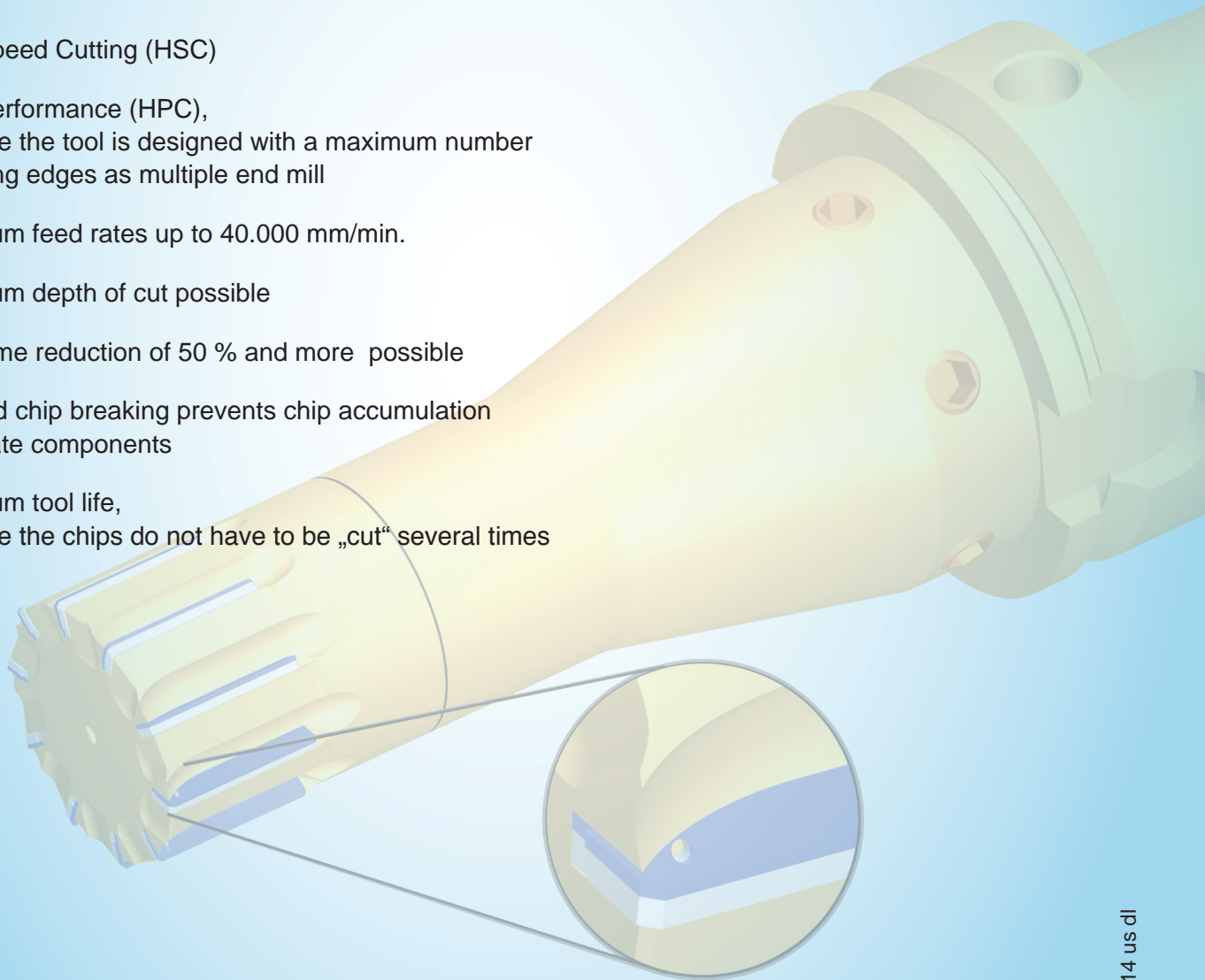

LACH DIAMOND INC.
4350 Airwest Drive, S.E.
Grand Rapids, MI 49512
Tel. (616) 698-0101
Fax (616) 698-0232
office@lachdiamond.com
www.lach-diamond.com

**LACH
DIAMOND INC.**

